



Network Security Standards

Key distribution

Kerberos

SSL/TLS

Many-to-Many Authentication

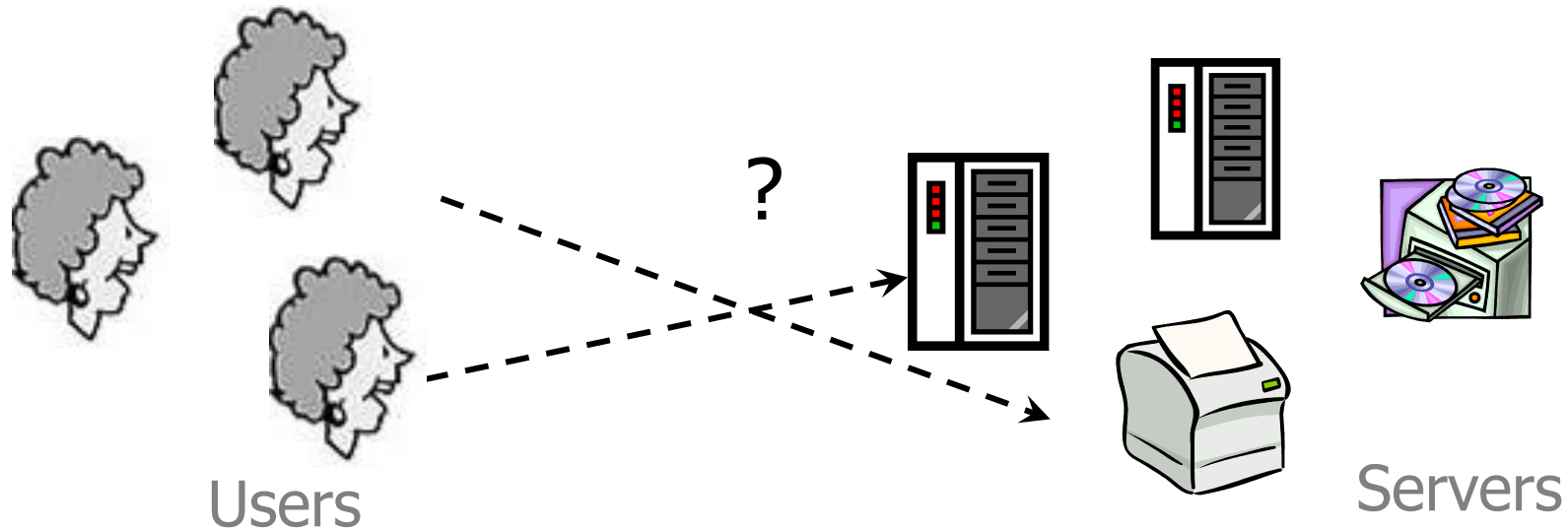

How do users prove their identities when requesting services from machines on the network?

Naïve solution: every server knows every user's password

- **Insecure:** compromise of one server is enough to compromise all users
- **Inefficient:** to change his password, user must contact every server

Key Distribution - Secret Keys

- ❑ What if there are millions of users and thousands of servers?
- ❑ Could configure n^2 keys
- ❑ Better is to use a Key Distribution Center
 - Everyone has one key
 - The KDC knows them all
 - The KDC assigns a key to any pair who need to talk

Goals

❑ Requirements

- Security (sniffers and malicious users)
- Reliability
- Transparency
 - Users should not be aware of authentication action
 - Entering password is Ok, if done rarely
- Scalability

❑ Threats

- User impersonation:
can't trust workstations to verify users' identities
- Network address impersonation: Spoofing
- Eavesdropping, tampering and replay to gain unauthorized access

Solution: trusted third party

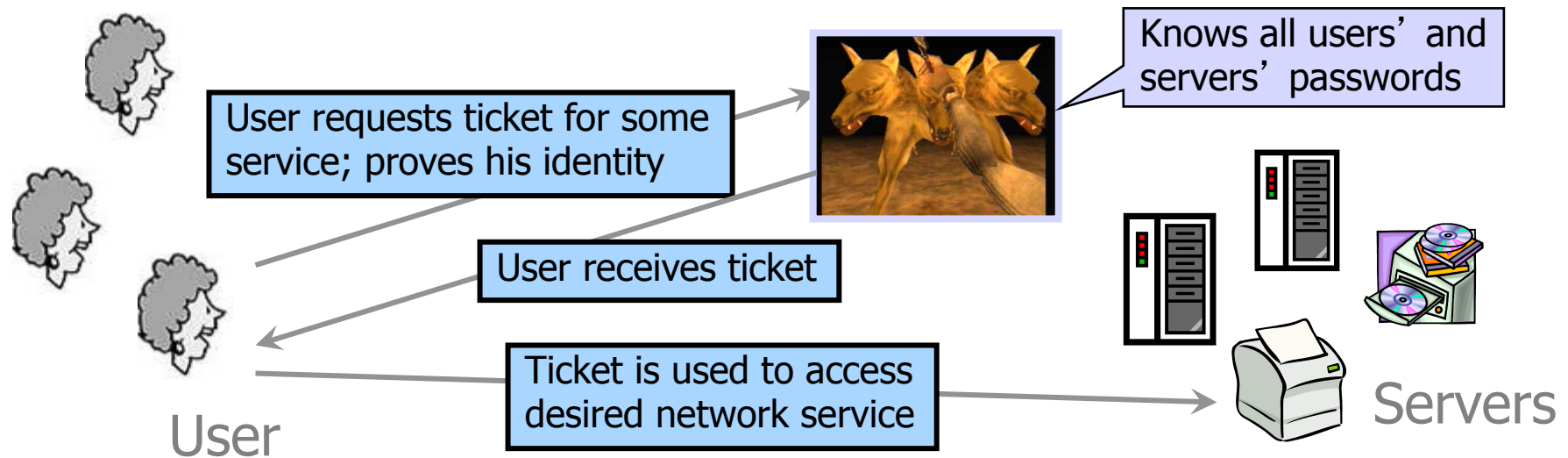

- ❑ Trusted **authentication service** on the network
 - Knows all passwords, can grant access to any server
 - Convenient, but also the single point of failure
 - Requires high level of physical security

A Common Variant

Alice

KDC

Bob

A wants to talk to B →

Randomly choose K_{ab}

← $\{\text{"B"}, K_{ab}\}_{K_a}, \{\text{"A"}, K_{ab}\}_{K_b}$

→ $\{\text{"A"}, K_{ab}\}_{K_b}, \{\text{Message}\}_{K_{ab}}$

KDC Realms

- ❑ KDCs scale up to hundreds of clients, but not millions
- ❑ There's no one who everyone in the world is willing to trust with their secrets
- ❑ KDC Realm: a KDC and the users of that KDC

KDC Realms

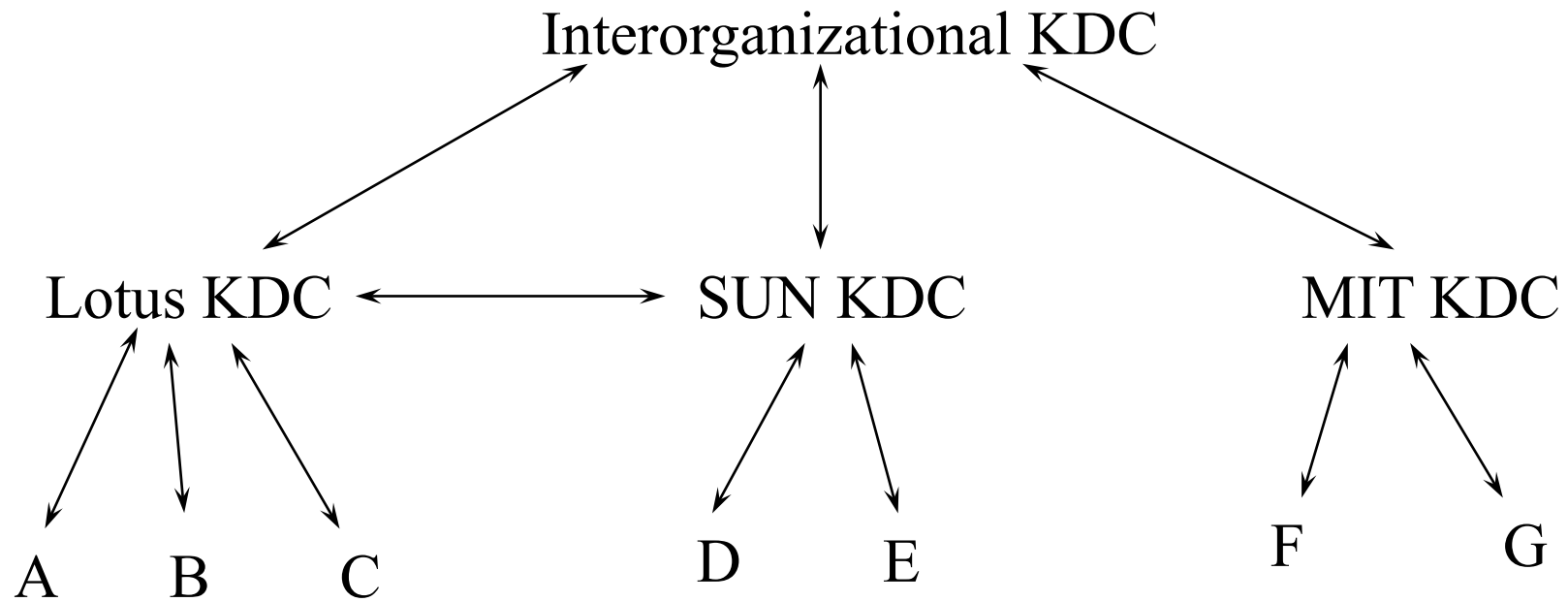

Interrealm KDCs

- ❑ How would you talk to someone in another realm?
- ❑ How would you know what realm?
- ❑ How would you know a path to follow?
- ❑ What can bad KDCs do?
- ❑ How do you know what path was used? Why do you care?

KDC Hierarchies

- ❑ In hierarchy, what can each compromised KDC do?
- ❑ What would happen if root was compromised?
- ❑ If it's not a name-based hierarchy, how do you find a path?

What should a ticket look like?

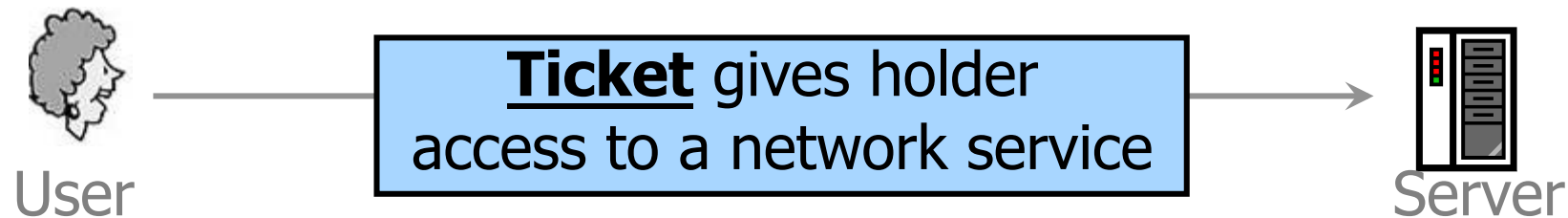

- ❑ Ticket cannot include server's plaintext password
 - Otherwise, next time user will access server directly without proving his identity to authentication service
- ❑ Solution: **encrypt** some information with a key derived from the server's password
 - Server can decrypt ticket and verify information
 - User does not learn server's password

What should a ticket include?

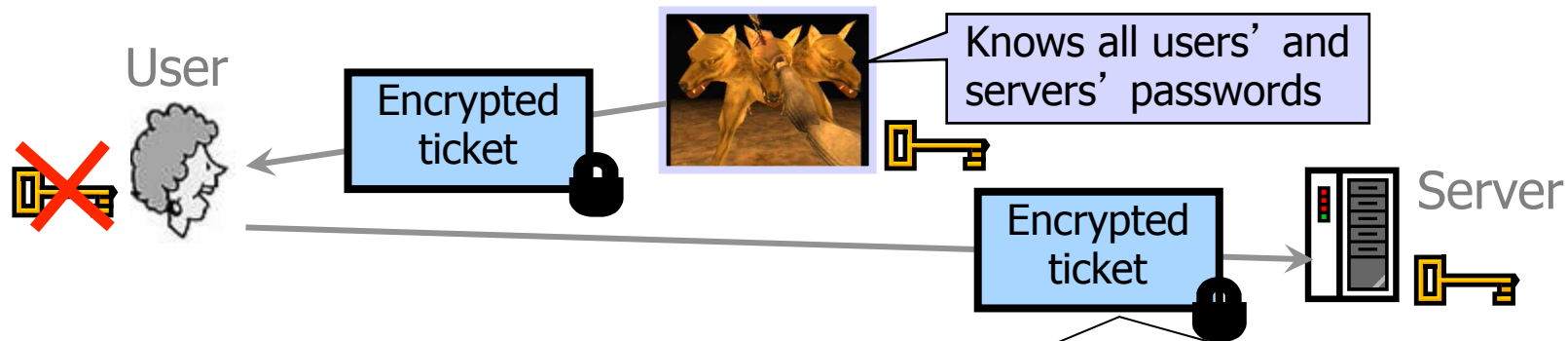

- User name
- Server name
- Address of user's workstation
 - Otherwise, a user on another workstation can steal the ticket and use it to gain access to the server
- Ticket lifetime
- A few other things (e.g., session key)

How is authentication done?

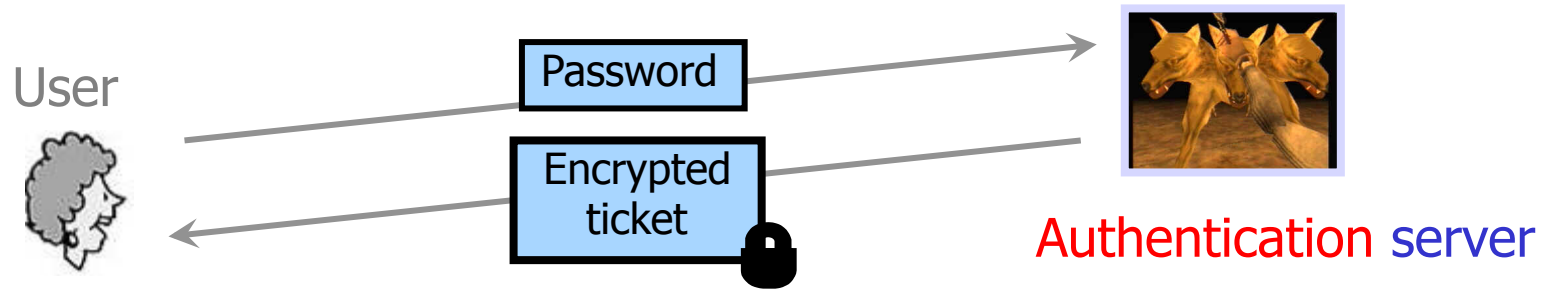

- ❑ **Insecure:** passwords are sent in plaintext
 - Eavesdropper can steal the password and later impersonate the user to the authentication server
- ❑ **Inconvenient:** need to send the password each time to obtain the ticket for any network service
 - Separate authentication for email, printing, etc.

Solution: Two-Step Authentication

- ❑ Prove identity **once** to obtain special TGTicket
 - Instead of password, use **key** derived from password
- ❑ Use TGT to get tickets for many network services

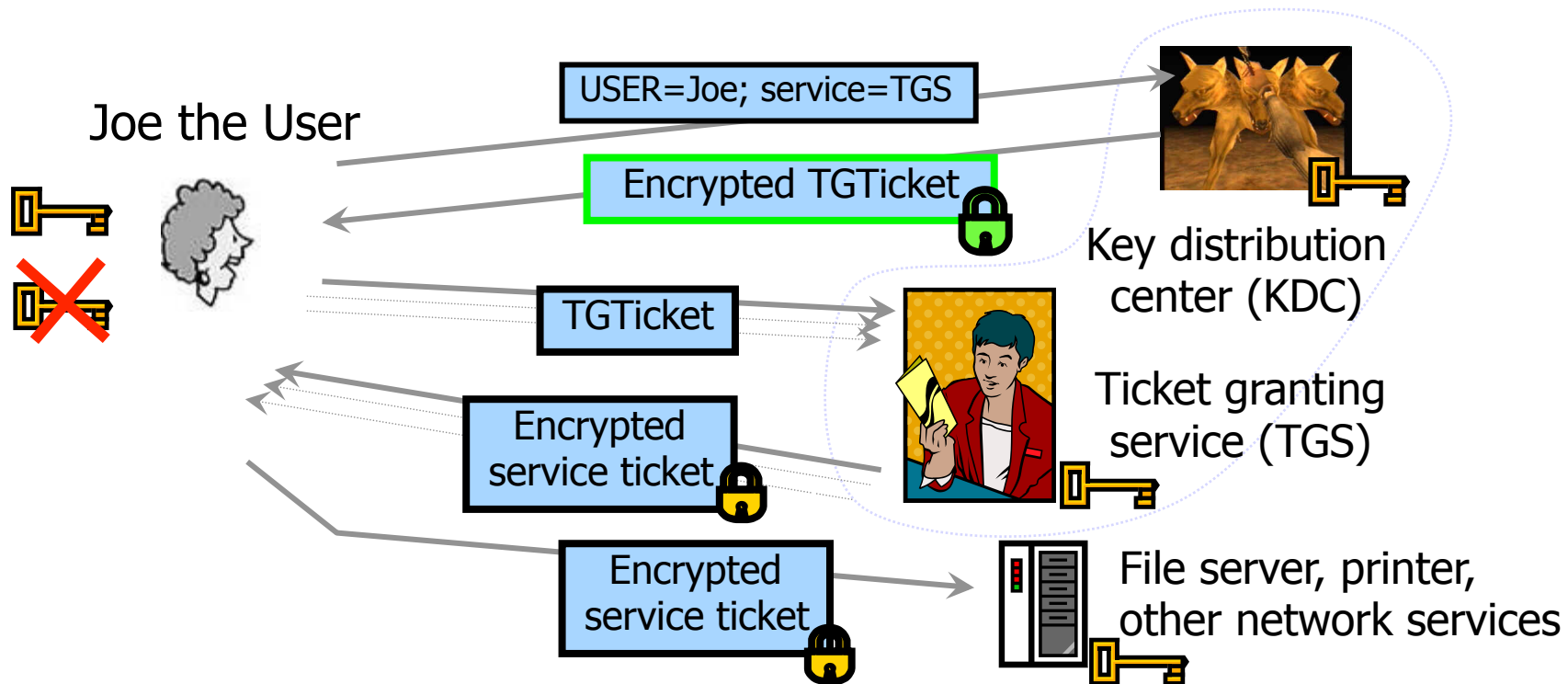

Still Not Good Enough

❑ Ticket hijacking

- Malicious user may steal the service ticket of another user on the same workstation and use it
 - IP address verification does not help
- Servers must be able to verify that the user who is presenting the ticket is the same user to whom the ticket was issued

❑ No server authentication

- Attacker may misconfigure the network so that he receives messages addressed to a legitimate server
 - Capture private information from users and/or deny service
- Servers must prove their identity to users

Key management

❑ Where do keys come from?

- Symmetric Ciphers: Key Distribution Center (KDC)
- Why?
 - Shared key for any communication pair does not scale and is cryptographically unwise – uses each key too much!

❑ Key lifetime / freshness?

- Long-lived key for authentication and session key negotiation
- Short-lived key for transfer
- Why?
 - Long-lived keys are tempting/easy targets (stream ciphers!!!)
 - Compromised old keys

Needham-Schroeder Protocol (1978)

- ❑ Basis of Kerberos
- ❑ Relies on a key distribution centre (KDC)
- ❑ KDC is part of the trusted computing base
 - Knows secret keys of all participants
 - Manages N keys (instead of $N(N-1)/2$)
- ❑ Solves two key problems
 - Distribution of shared secret key
 - Mutual authentication



Needham and Schroeder's Protocol

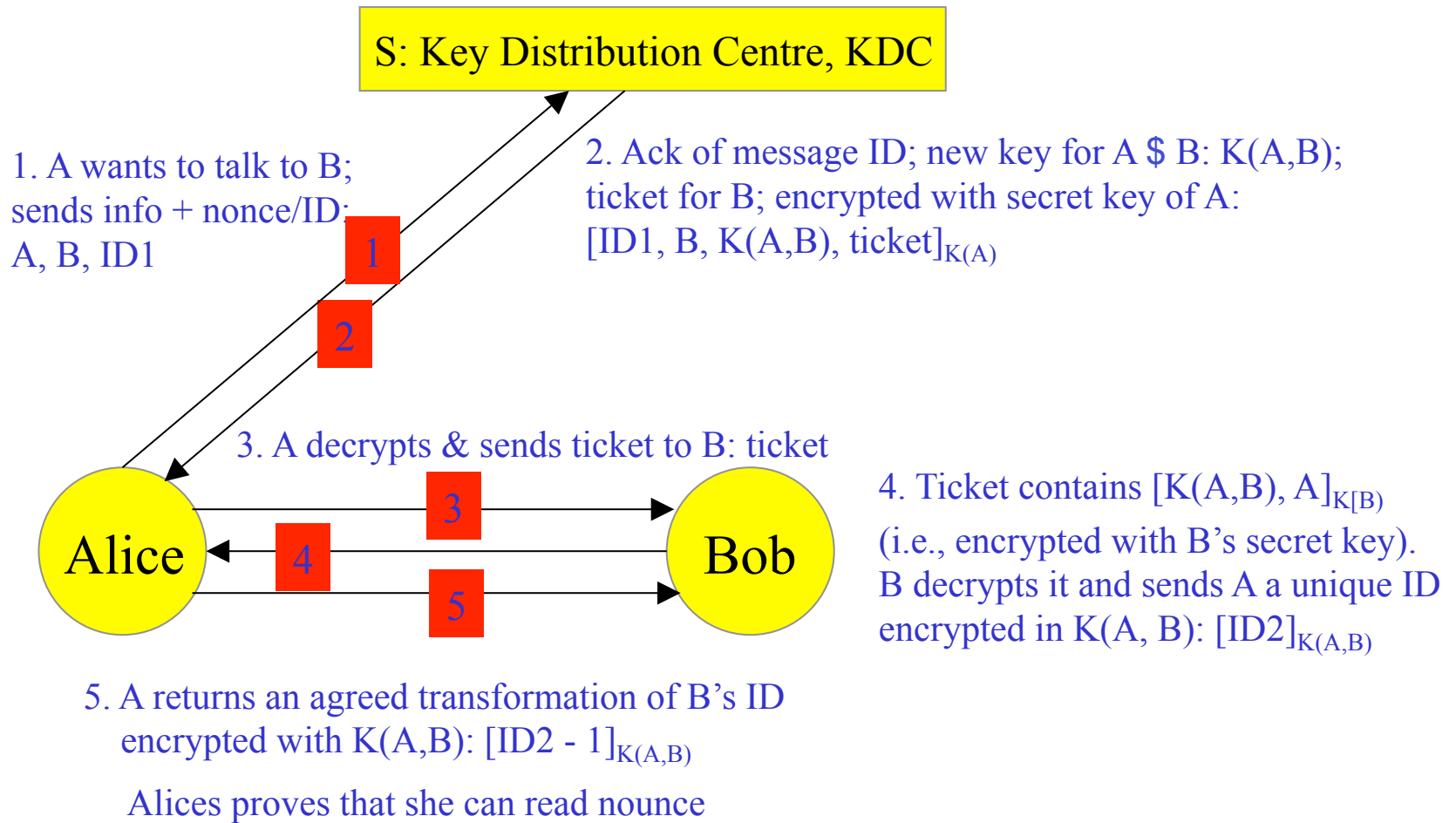

Cryptographic protocol design is hard

- ❑ Bob never proved his identity to Alice
- ❑ If $K(A,B)$ is compromised attacker can impersonate Alice forever
- ❑ Denning and Sacco proposed a fix in 1981
- ❑ Needham found a flaw in their fix in 1994
- ❑ Another flaw found in public key version in 1995 (it is actually only a 3-message protocol)
- ❑ **Cryptographic protocol design is hard!!!**

Kerberos [RFC4120, NeumanTs' 94]

- ❑ Kerberos: (“der Höllenhund”) The watch dog of Hades, whose duty it was to guard the entrance – against whom or what does not clearly appear; ... it is known to have had three heads...
 - Ambrose Bierce, The Enlarged Devil's Dictionary
- ❑ Designed to authenticate users to servers
- ❑ Users use their password to authenticate themselves
- ❑ It is possible to protect the Kerberos server
- ❑ Assumption: The workstations have not been tampered with!

Kerberos lingua

- ❑ Principles: Kerberos entity
 - User or system service
 - Triples: (primary name, instance, realm)
Realm: identifies Kerberos server
 - Examples:
username@some.domain.name
somehost/lpr@other.domain
- ❑ Tickets: cryptographically sealed messages with session keys and identifiers
 - Used to obtain a service
- ❑ Ticket-Granting ticket (TGT)
 - Ticket to obtain other tickets

How Kerberos works

❑ Relies on

- Kerberos key distribution center (KDC)
- Ticket granting service (TGS)

❑ Users

- Have to present a ticket to obtain a service
- Request TGT from KDC via extended Needham-Schroeder (using their shared secret with the KDC)
- Request tickets from TGS via extended Needham-Schroeder (using the TGT)

Kerberos picture

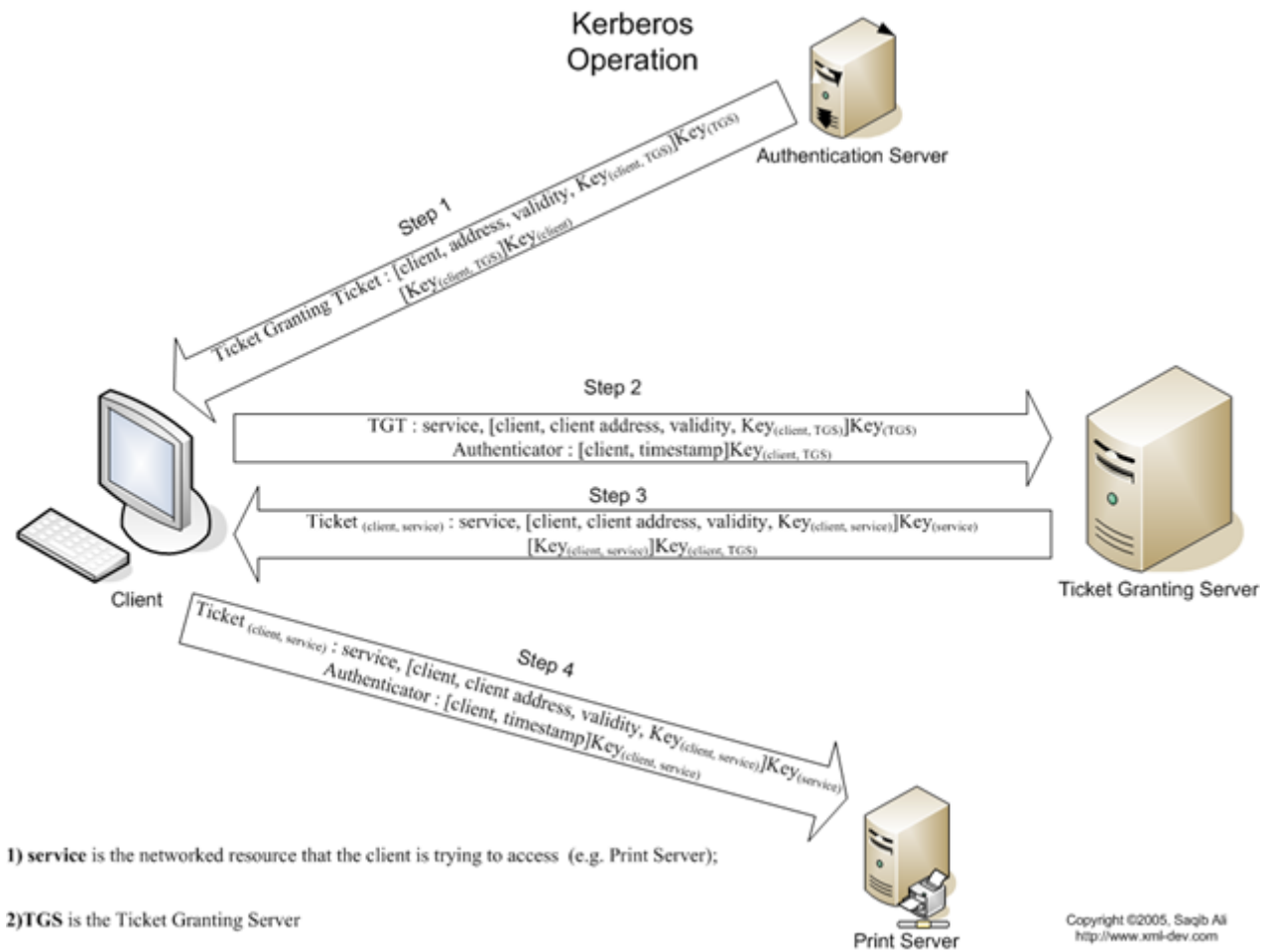

Symmetric keys in Kerberos

- K_C is long-term key for each client C
 - Derived from user's password
 - Known to client and key distribution center (KDC)
- K_{TGS} is long-term key of TGS
 - Known to KDC and ticket granting service (TGS)
- K_V is long-term key of each service V
 - Known to V and TGS; separate key for each service
- $K_{C,TGS}$ is short-term key between C and TGS
 - Created by KDC, known to C and TGS
- $K_{C,V}$ is short-term key between C and V
 - Created by TGS, known to C and V

“Single logon” authentication

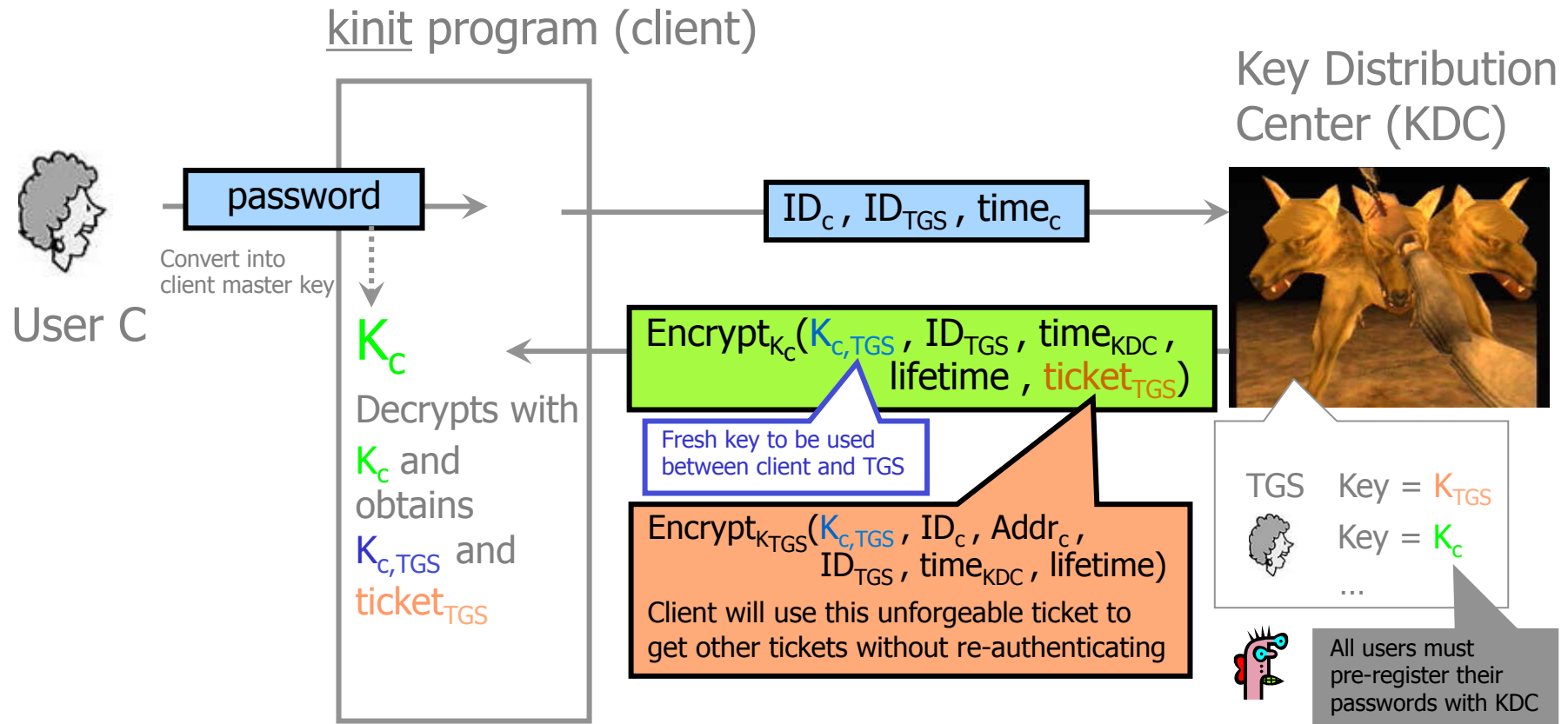

- Client only needs to obtain TGTicket **once** (say, every morning)
 - Ticket is encrypted; client cannot forge it or tamper with it

Obtaining a service ticket

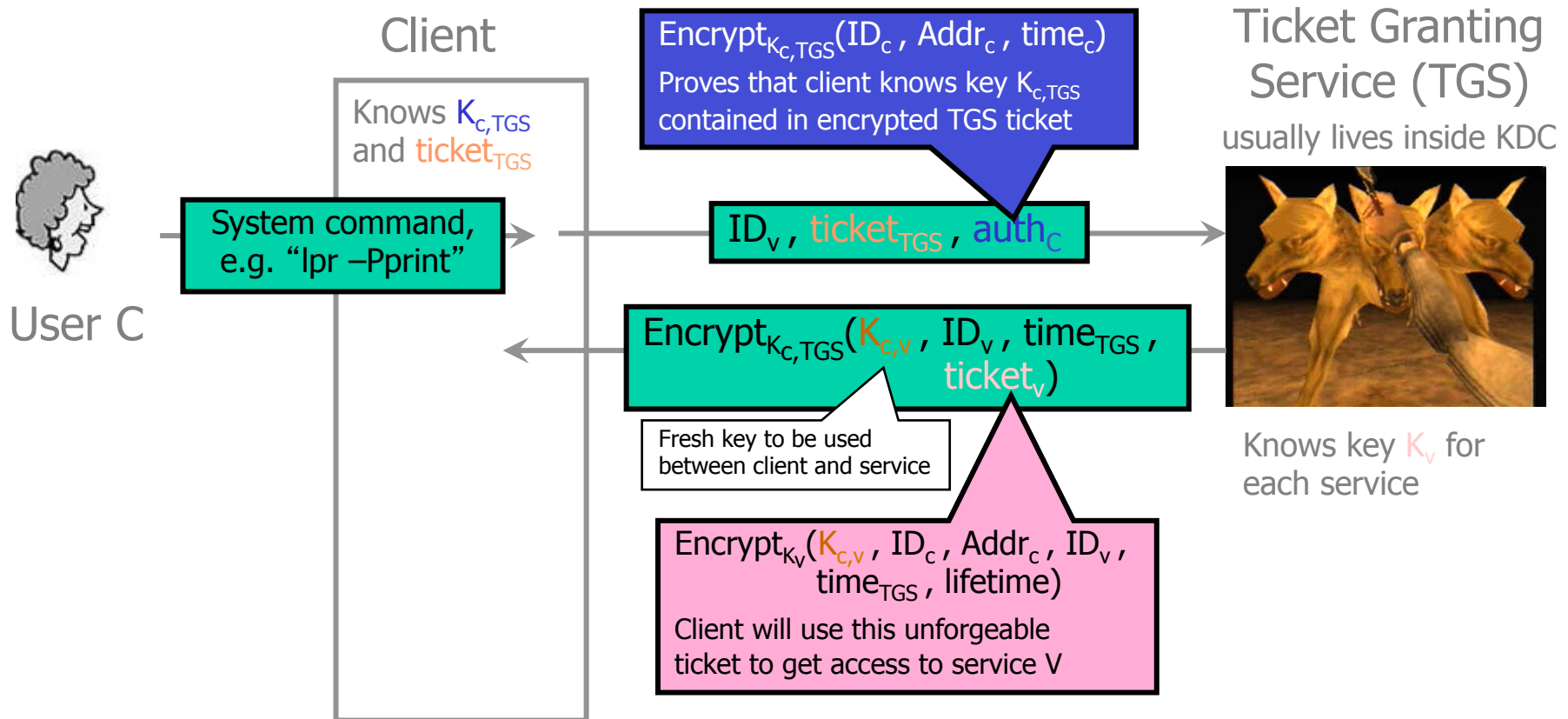

- Client uses TGTicket to obtain a service ticket and a short-term key for each network service
 - One encrypted, unforgeable ticket per service (printer, email, etc.)

Obtaining service

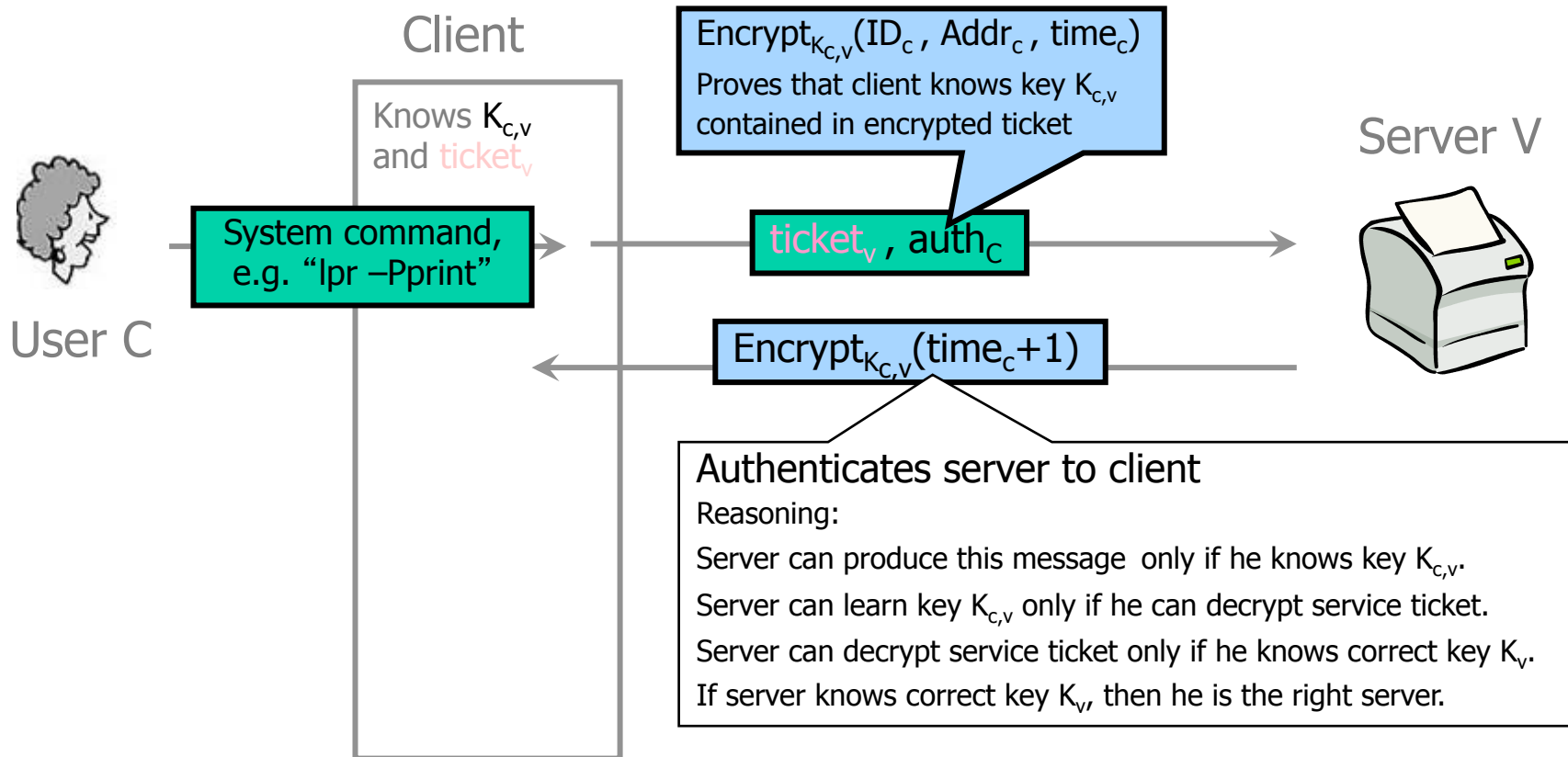

- For each service request, client uses the short-term key for that service and the ticket he received from TGS

Kerberos in large networks

- ❑ One KDC isn't enough for large networks (why?)
- ❑ Network is divided into **realms**
 - KDCs in different realms have different key databases
- ❑ To access a service in another realm, users must...
 - Get ticket for home-realm TGS from home-realm KDC
 - Get ticket for remote-realm TGS from home-realm TGS
 - As if remote-realm TGS were just another network service
 - Get ticket for remote service from that realm's TGS
 - Use remote-realm ticket to access service
 - $N(N-1)/2$ key exchanges for full N-realm interoperation

Summary of Kerberos

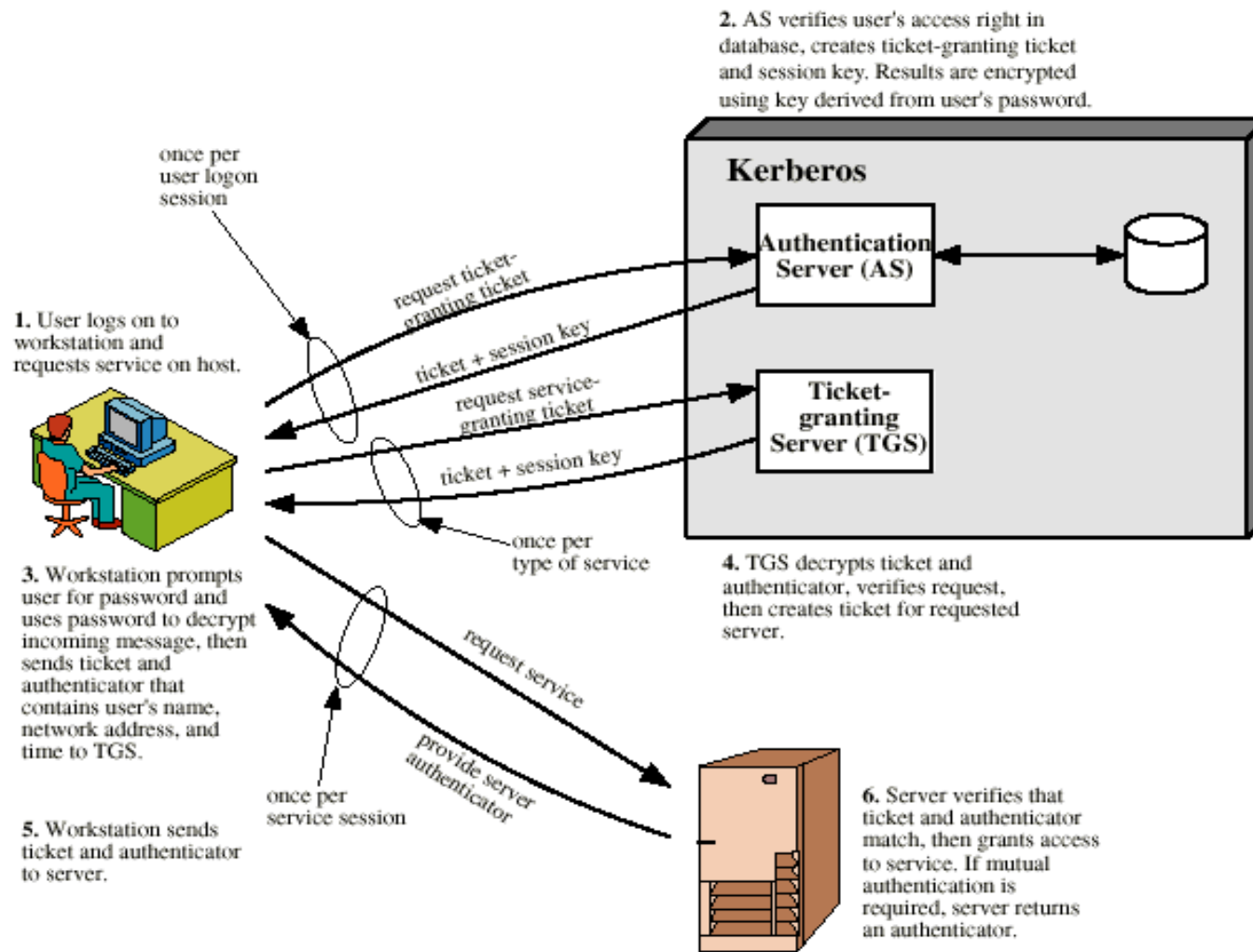

Important ideas in Kerberos

- ❑ Use of short-term **session keys**
 - Minimize distribution and use of long-term secrets; only used to derive short-term session keys
 - Separate short-term key for each user-server pair
 - But multiple user-server sessions reuse the same key!
- ❑ Proofs of identity are based on **authenticators**
 - Client encrypts his identity, address and current time using short-term session key
 - Also prevents replays (if clocks are globally synchronized)
 - Server learns this key separately (via encrypted ticket that client cannot decrypt) and verifies user's identity
- ❑ Symmetric cryptography only

Problematic issues

- ❑ Password dictionary attacks on client master keys
- ❑ Ticket cache security
- ❑ Subverted login command
- ❑ Replay of authenticators
 - 5-minute lifetimes long enough for replay
 - Timestamps assume global, secure synchronized clocks
 - Challenge-response would be better
- ❑ Same user-server key used for all sessions
- ❑ Homebrewed PCBC mode of encryption
 - Tries to combine integrity check with encryption
- ❑ Extraneous double encryption of tickets
- ❑ No ticket delegation
 - Printer cannot fetch email from server on your behalf

Kerberos Version 5

- ❑ Better user-server authentication
 - Separate subkey for each user-server session instead of re-using the session key contained in ticket
 - Authentication via subkeys, not timestamp increments
- ❑ Authentication forwarding
 - Servers can access other servers on user's behalf
- ❑ Realm hierarchies for inter-realm authentication
- ❑ Richer ticket functionality
- ❑ Explicit integrity checking + standard CBC mode
- ❑ Multiple encryption schemes, not just DES

Practical Uses of Kerberos

- ❑ Email, FTP, network file systems and many other applications have been **kerberized**
 - Use of Kerberos is transparent for the end user
 - Transparency is important for usability!
- ❑ Standard authentication for Windows (since W2K)
- ❑ Local authentication
 - login and su in OpenBSD
- ❑ Authentication for network protocols
 - rlogin, rsh, telnet, afs
- ❑ Secure windowing systems
 - xdm, kx

SSL: Secure Sockets Layer

- ❑ Widely deployed
 - Supported by almost all Web browsers and servers
 - **https**
 - Lots \$ spent over SSL
- ❑ Originally designed by Netscape in 1993
- ❑ Proposed standard:
 - **TLS: transport layer security (RFC 4346)**
- ❑ Provides
 - **Confidentiality**
 - **Integrity**
 - **Authentication**
- ❑ Original goals:
 - Secure Web e-commerce transactions
 - **Encryption** (especially credit-card numbers)
 - **Web-server authentication**
 - **Optional client authentication**
 - **Minimum hassle** for business with new merchant
- ❑ Available to all TCP applications
 - **Secure socket interface**

SSL and TCP/IP

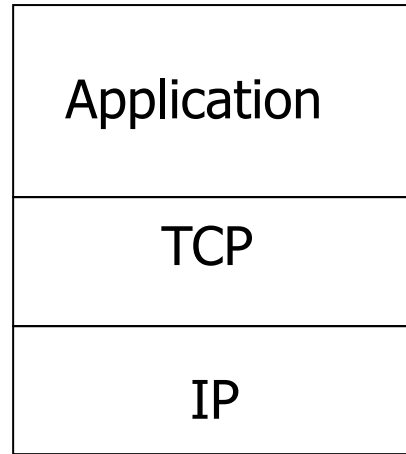

Normal Application

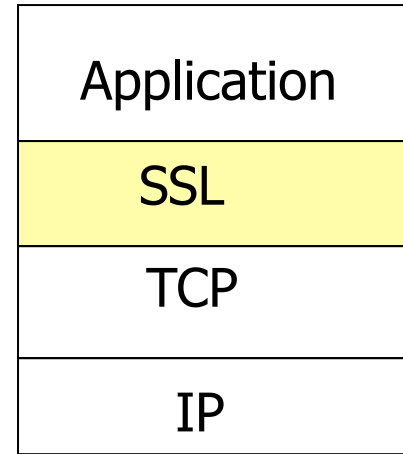

Application
with SSL

- ❑ SSL provides application programming interface (API) to applications
- ❑ Many SSL libraries/classes readily available, including C, C++, Java, Perl, ...

Could do something like PGP

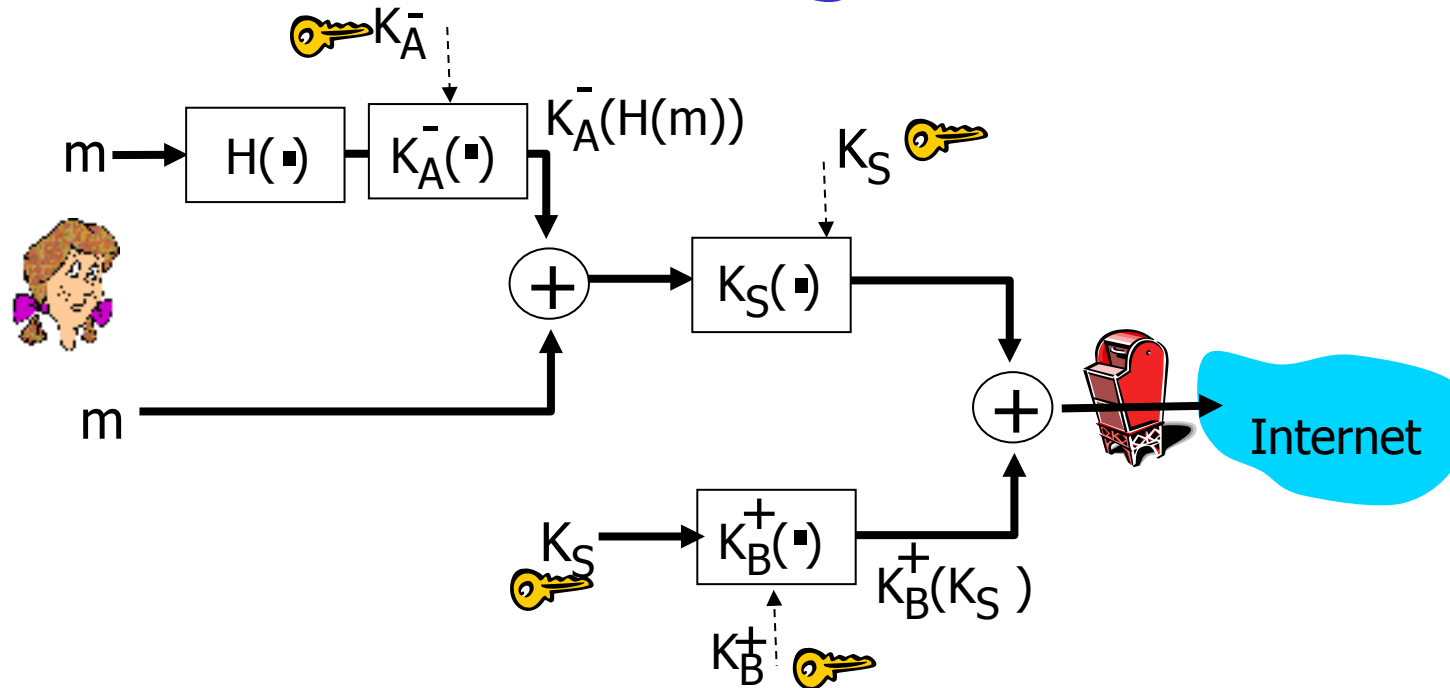

- ❑ But want to send byte streams & interactive data
- ❑ Want a set of secret keys for entire connection
- ❑ Want certificate exchange as part of protocol: handshake phase

Toy SSL: a simple secure channel

- ❑ **Handshake:** Alice and Bob use their certificates and private keys to authenticate each other and exchange shared secret
- ❑ **Key Derivation:** Alice and Bob use shared secret to derive set of keys
- ❑ **Data Transfer:** Data to be transferred is broken up into a series of records
- ❑ **Connection Closure:** Special messages to securely close connection

Toy: simple handshake

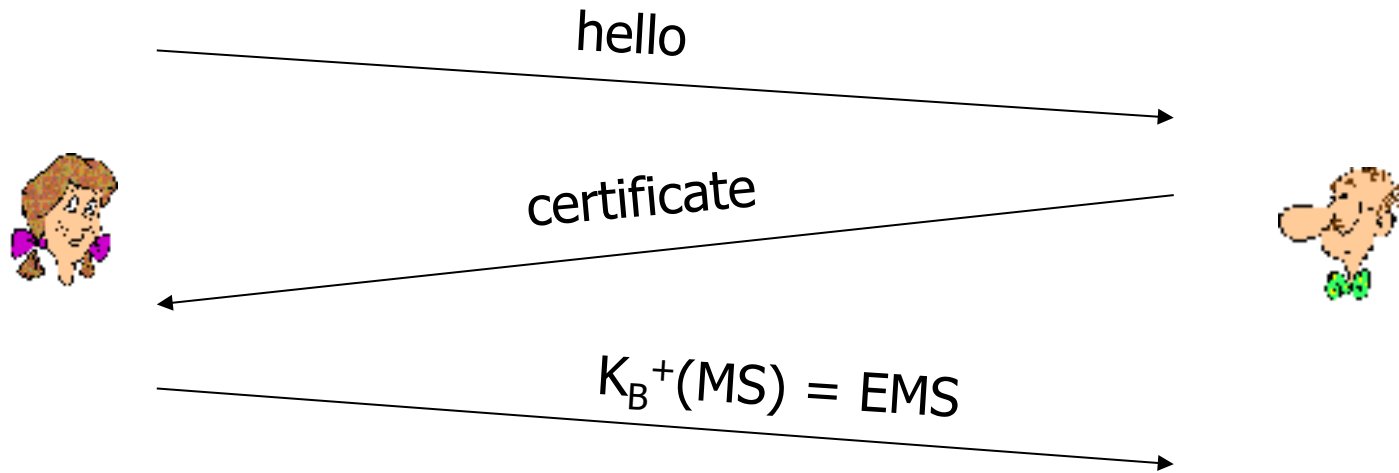

- ❑ MS = master secret
- ❑ EMS = encrypted master secret

Toy: key derivation

- ❑ Bad to use same key for >1 cryptographic op.
 - Different keys for message authentication code (MAC) and encryption
- ❑ Four keys:
 - K_c = encryption key for data sent from client to server
 - M_c = MAC key for data sent from client to server
 - E_s = encryption key for data sent from server to client
 - M_s = MAC key for data sent from server to client
- ❑ Keys derived via key derivation function (KDF)
 - Takes master secret and (possibly) some additional random data and creates the keys

Recall MAC

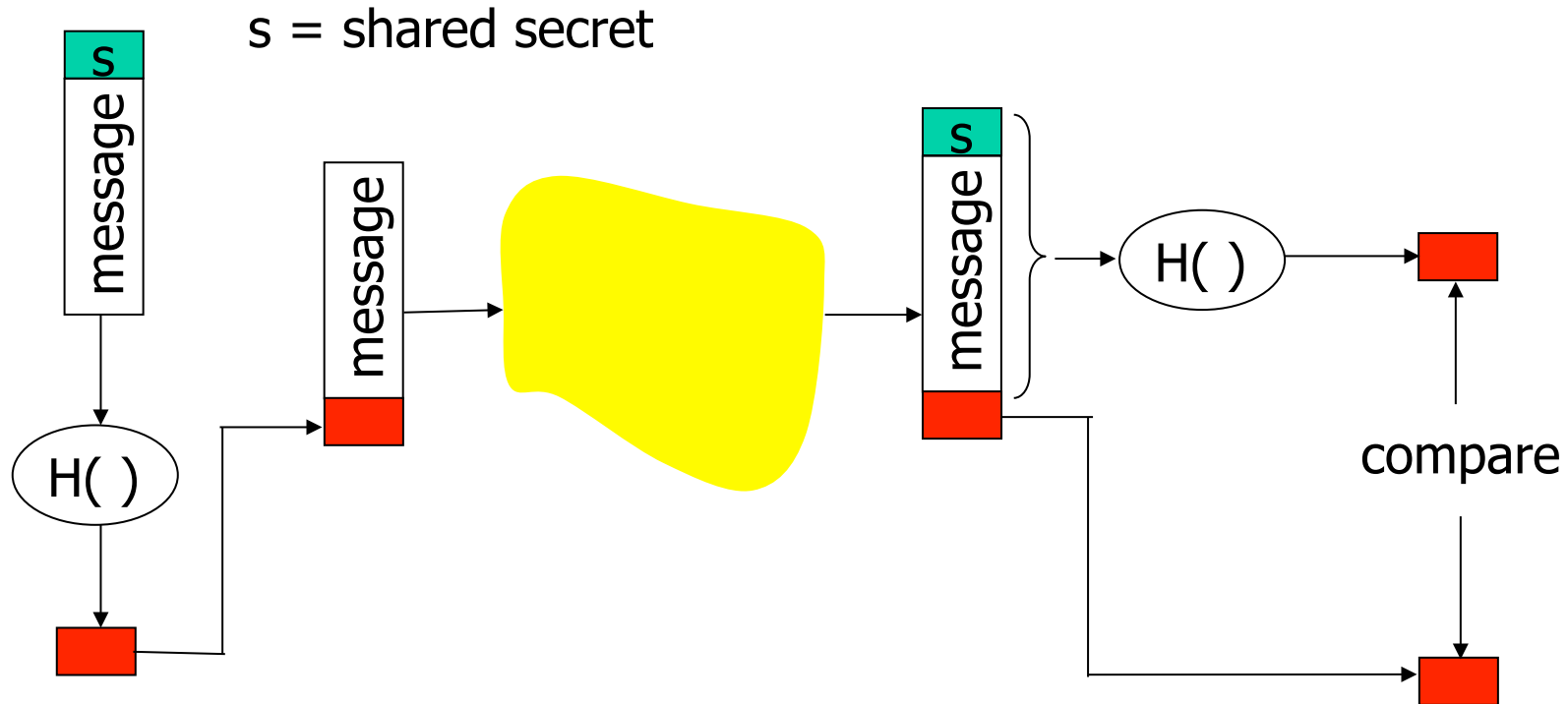

- ❑ Recall that HMAC is a standardized MAC algorithm
- ❑ SSL uses a variation of HMAC
- ❑ TLS uses HMAC

Toy: data records

- ❑ Why not encrypt data in stream as we write it to TCP?
 - Where to put MAC?
 - At end? No message integrity until all data processed.
 - E.g.: instant messaging: how to do integrity check over all bytes before displaying?
- ❑ Break stream in series of records
 - Each record carries a MAC
 - Receiver can act on each record as it arrives
- ❑ Issue for receiver: how to distinguish MAC from data
 - Want to use variable-length records



Toy: sequence numbers

- ❑ Attacker can capture and replay record or re-order records
- ❑ Solution: put sequence number into MAC:
 - $MAC = MAC(M_x, \text{sequence} || \text{data})$
 - Sequence number serves as nonce for record
 - Note: no sequence number field
- ❑ Attacker could still replay all of the records
 - Use session nonce as well

Toy: control information

- ❑ Truncation attack:
 - Attacker forges TCP connection close segment
 - One or both sides thinks there is less data than there actually is.
- ❑ Solution: record types, with special type for closure
 - Type 0 for data; type 1 for closure
- ❑ $MAC = MAC(M_x, \text{sequence} || \text{type} || \text{data})$



Toy SSL: summary



bob.com

encrypted

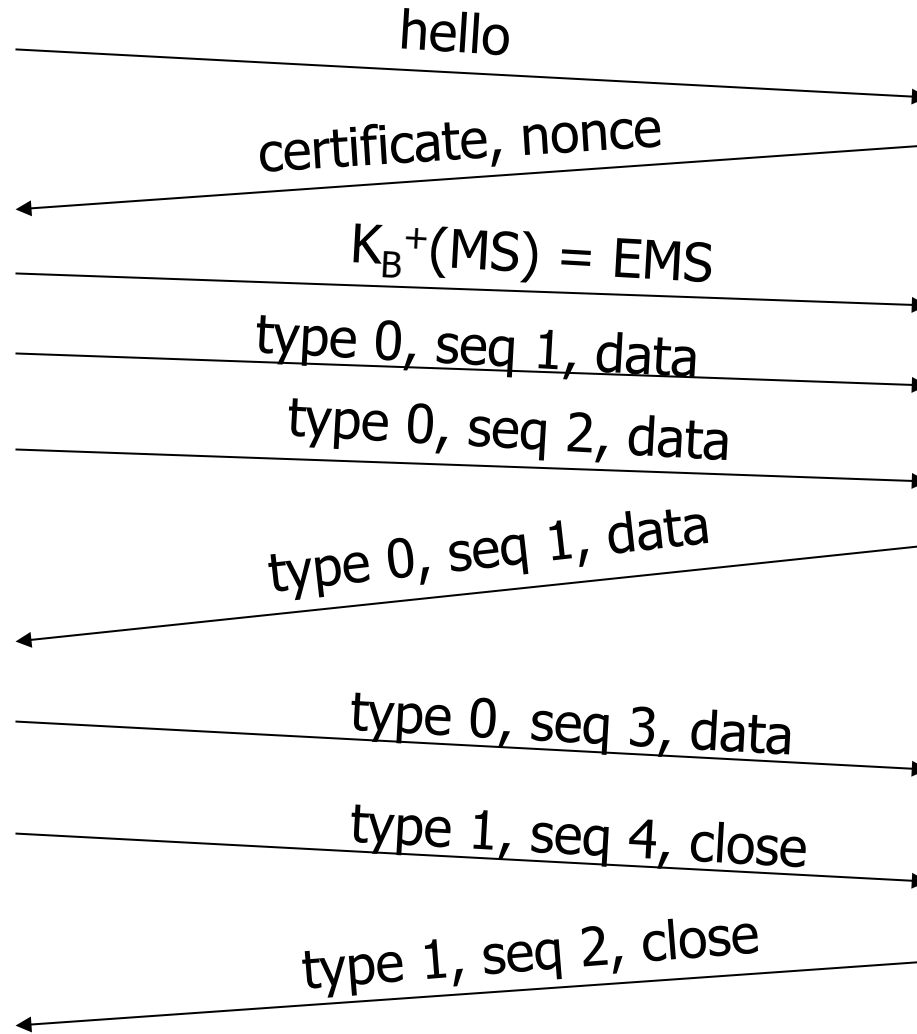

Toy SSL is not complete

- ❑ How long are the fields?
- ❑ What encryption protocols?
- ❑ No negotiation
 - Allow support for different encryption algorithms
 - Allow client and server to choose together specific algorithm before data transfer

Most common symmetric ciphers in SSL

- ❑ DES – Data Encryption Standard: block
- ❑ 3DES – Triple strength: block
- ❑ RC2 – Rivest Cipher 2: block
- ❑ RC4 – Rivest Cipher 4: stream

Public key encryption

- ❑ RSA

SSL cipher suite

- ❑ Cipher suite
 - Public-key algorithm
 - Symmetric encryption algorithm
 - MAC algorithm
- ❑ SSL supports a variety of cipher suites
- ❑ Negotiation:
 - Client offers choice; server picks one

Real SSL: handshake (1)

Purpose

1. Server authentication
2. Negotiation: agree on crypto algorithms
3. Establish keys
4. Client authentication (optional)

Real SSL: handshake (2)

1. **Client** sends list of algorithms, along with client nonce
2. **Server** chooses algorithms from list;
sends back: choice + certificate + server nonce
3. **Client** verifies certificate,
extracts server's public key,
generates pre_master_secret,
encrypts with server's public key,
sends to server
4. **Client** and **server** independently compute encryption and
MAC keys from pre_master_secret and nonces
5. **Client** sends MAC of all handshake messages
6. **Server** sends MAC of all handshake messages

Real SSL: handshaking (3)

Last 2 steps protect against tampering of handshake

- ❑ Client typically offers range of algorithms:
some strong, some weak
- ❑ Man-in-the middle can delete stronger algorithms
- ❑ Last 2 steps prevent this
 - Note: last two messages are encrypted!

Handshake types

- ❑ All handshake messages (with SSL header) have 1 byte type field: Types
 - ClientHello
 - ServerHello
 - Certificate
 - ServerKeyExchange
 - CertificateRequest
 - ServerHelloDone
 - CertificateVerify
 - ClientKeyExchange
 - Finished

SSL record protocol

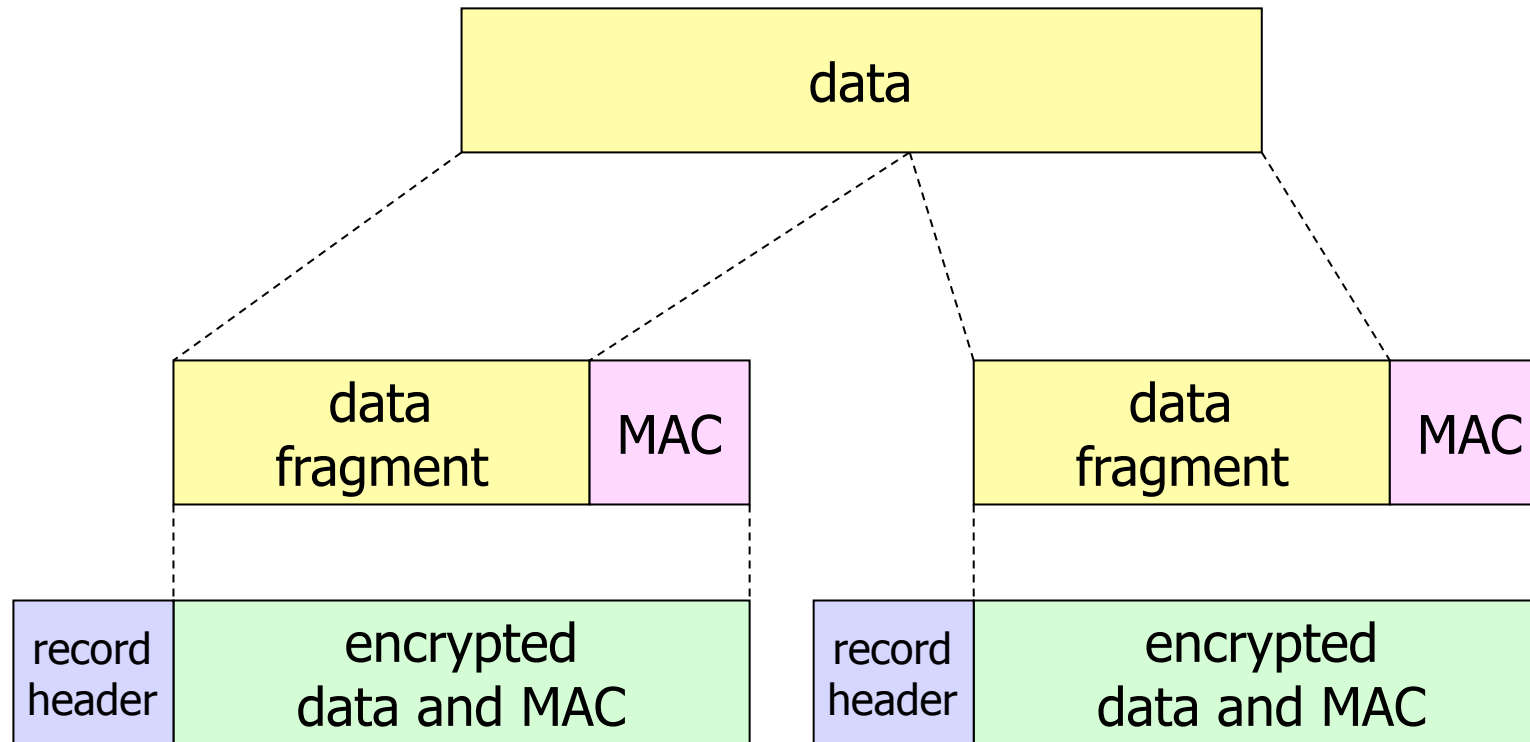

Record header: content type; version; length

MAC: includes sequence number, MAC key M_x

Fragment: each SSL fragment 2^{14} bytes (~ 16 Kbytes)

SSL record format

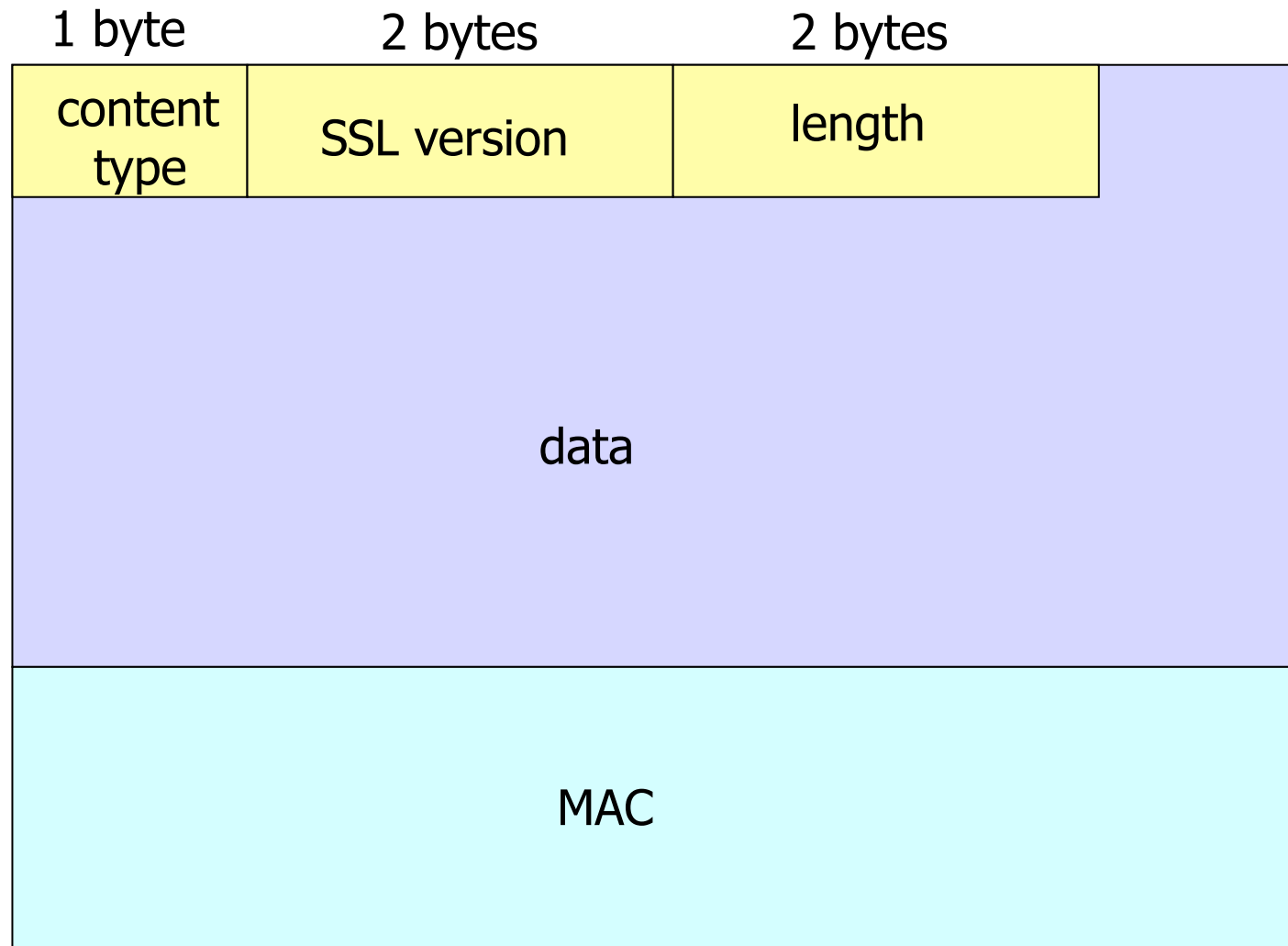

Data and MAC encrypted (symmetric key algorithm)

Content types in record header

- ❑ Application_data
- ❑ Alert
 - Signaling errors during handshake
- ❑ Handshake
 - Initial handshake messages are carried in records of type “handshake”
 - Handshake messages in turn have their own types
- ❑ Change_cipher_spec
 - Indicates change in encryption and authentication algorithms

SSL: real connection

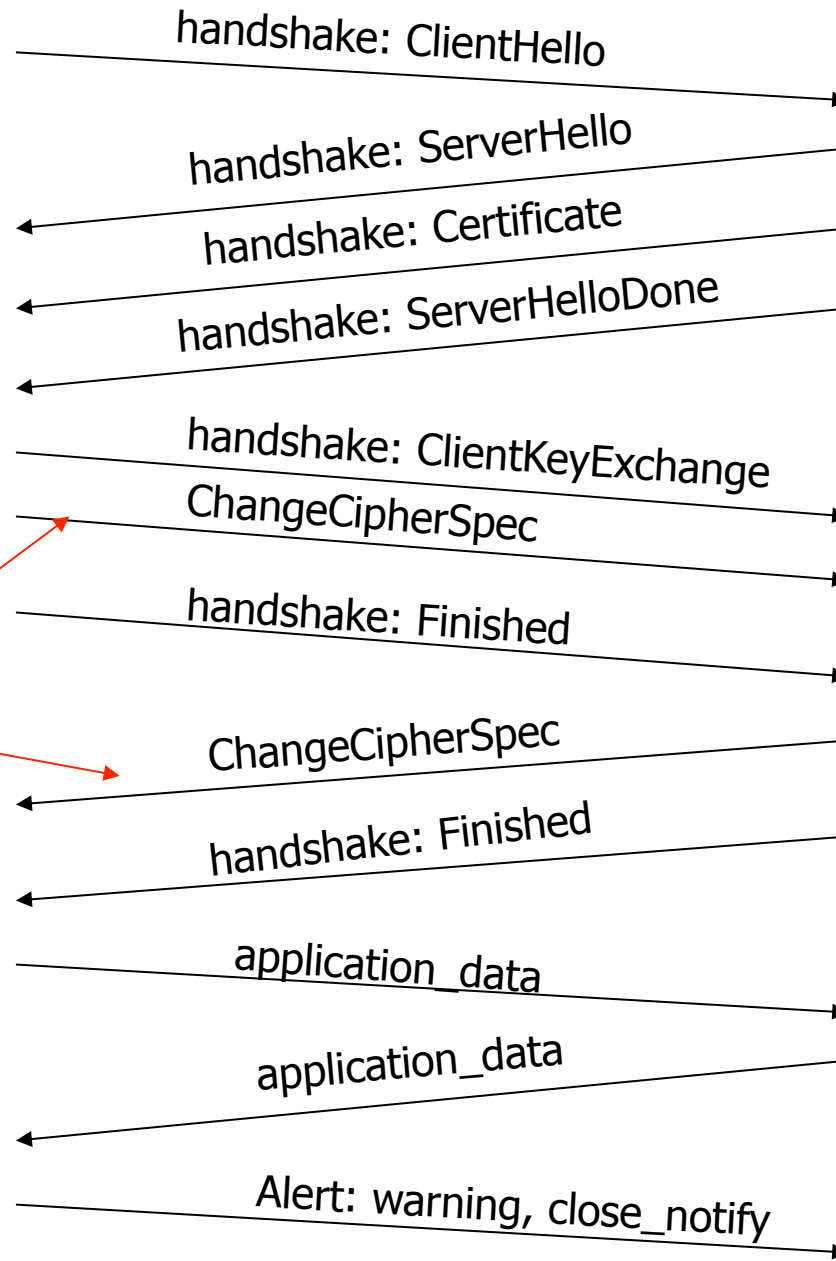

Everything henceforth is encrypted

TCP Fin follows

Comments about trace messages

ClientHello

- ❑ Random: 32-byte nonce

ServerHello

- ❑ Cipher suite: RSA key exchange, DES-CBC message encryption, SHA digest
- ❑ Random: 32-byte nonce
- ❑ Session_id: used for session resumption

Certificate

- ❑ X.509 format
- ❑ Subject: company info
- ❑ Issuer: CA
- ❑ Certificate = public key

ClientKeyExchange

- ❑ Includes encrypted PreMasterSecret

Finished

- ❑ MAC of concatenation of handshake messages

Key derivation

- ❑ Client random, server random, and pre-master secret input into pseudo random-number generator.
 - Produces master secret
- ❑ Master secret, client and server random numbers into another random-number generator
 - Produces “key block”
- ❑ Key block sliced and diced:
 - Client MAC key
 - Server MAC key
 - Client encryption key
 - Server encryption key
 - Client initialization vector (IV)
 - Server initialization vector (IV)

SSL performance

- ❑ Recall: big-number operations in public-key crypto are CPU intensive
- ❑ Server handshake
 - Typically over half SSL handshake CPU time goes to RSA decryption of the encrypted `pre_master_secret`
- ❑ Client handshake
 - Public key encryption is less expensive
 - Server is handshake bottleneck
- ❑ Data transfer
 - Symmetric encryption
 - MAC calculation
 - Neither is as CPU intensive as public-key decryption

Session resumption

- ❑ Full handshake is expensive: CPU time
- ❑ If the client and server have already communicated once, they can skip handshake and proceed directly to data transfer
 - Session caching
 - For a given session, client and server store `session_id`, `master_secret`, negotiated ciphers
- ❑ Client sends `session_id` in `ClientHello`
- ❑ Server then agrees to resume in `ServerHello`
 - New `key_block` computed from `master_secret` and client and server random numbers

Client authentication

- ❑ SSL can also authenticate client
- ❑ Server sends a CertificateRequest message to client

Who issues Web certificates?

- ❑ Browser comes with list of built-in certificate authorities
- ❑ Firefox: 138(?) certificate authorities!
- ❑ Do you trust them all to be honest and competent?
- ❑ Do you even know them?

E.g.: Baltimore Cybertrust

- Sold its PKI in 2003
- What about the new owners?

Mountain America Credit Union

- ❑ Reputable CA issued certificate for Mountain America
- ❑ DNS name: www.mountain-america.net
- ❑ Looks OK
- ❑ But „real“ site at www.mtnamerica.org

- ❑ Which site is intended by the user?

Technical attack

❑ Scenario:

- Usually: shopping via unencrypted pages
- Click on „Checkout“ (or „Login“ on bank Web site)
- Next page – downloaded without SSL protection – has login link, which uses SSL

❑ Attack:

- Tamper with that page
- Will anyone notice
- Note some sites outsource payment processing!

❑ SUGGESTION:

- Attend our WEB browser security seminar starting this Friday!

▣ SUGGESTION:

- Attend our Computer Security project course!

SSL summary

- ❑ Cryptography itself seems correct
 - Indeed is formally verified after many iterations
- ❑ Human factors are dubious
- ❑ Most users don't know what a certificate is, or how to verify one

Moreover: hard to know what it should say!
- ❑ No rational basis for deciding whether or not to trust a CA