

# Network layer: Overview

- ❑ Network layer functions
- ❑ IP
- ❑ Routing and forwarding

# Network layer functions

- ❑ Transport packet from sending to receiving hosts
- ❑ Network layer protocols in *every* host, router

## Three important functions:

- ❑ *Path determination*: route taken by packets from source to dest. *Routing algorithms*
- ❑ *Switching*: move packets from router's input to appropriate router output

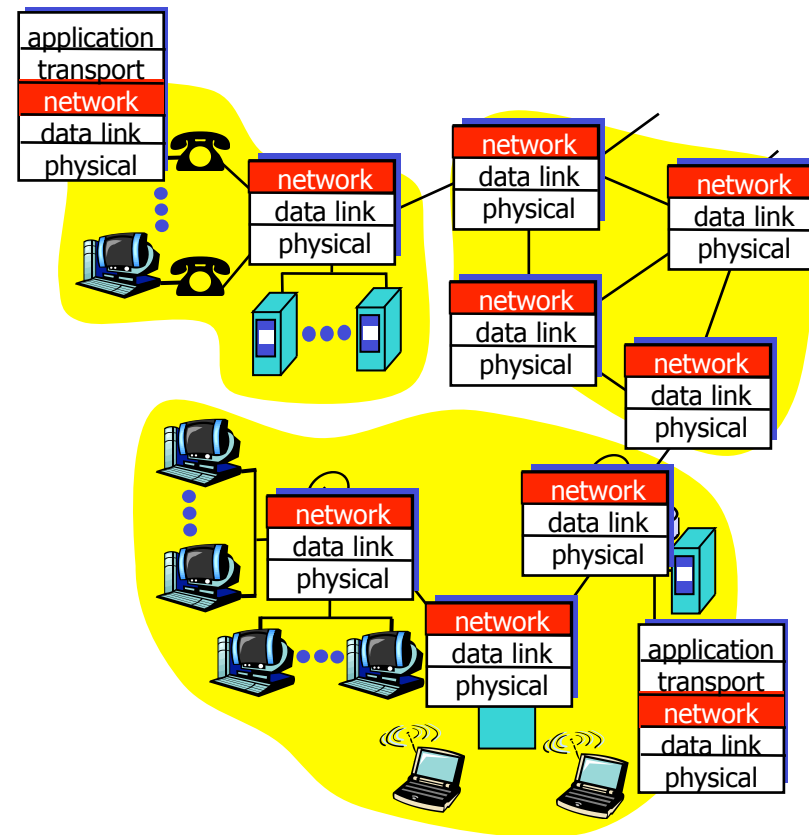

# IP addressing

- ❑ IP address: 32-bit identifier for host, router *interface*
- ❑ *Interface*: connection between host, router and physical link
  - Routers typically have multiple interfaces
  - Host may have multiple interfaces
  - IP addresses associated with interface, not host, router

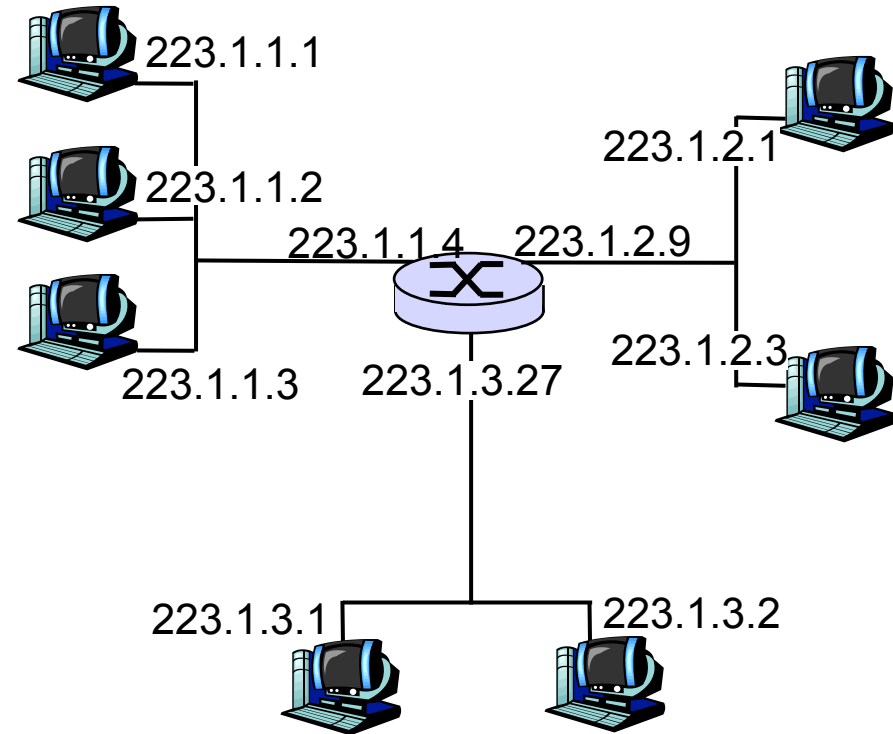

$$223.1.1.1 = \underbrace{11011111}_{223} \underbrace{00000001}_{1} \underbrace{00000001}_{1} \underbrace{00000001}_{1}$$

# IP addressing (2)

- ❑ IP address:
  - Network part (high order bits)
  - Host part (low order bits)
- ❑ *What's a network?*  
(from IP address perspective)
  - Device interfaces with same network part of IP address
  - Can physically reach each other without intervening router

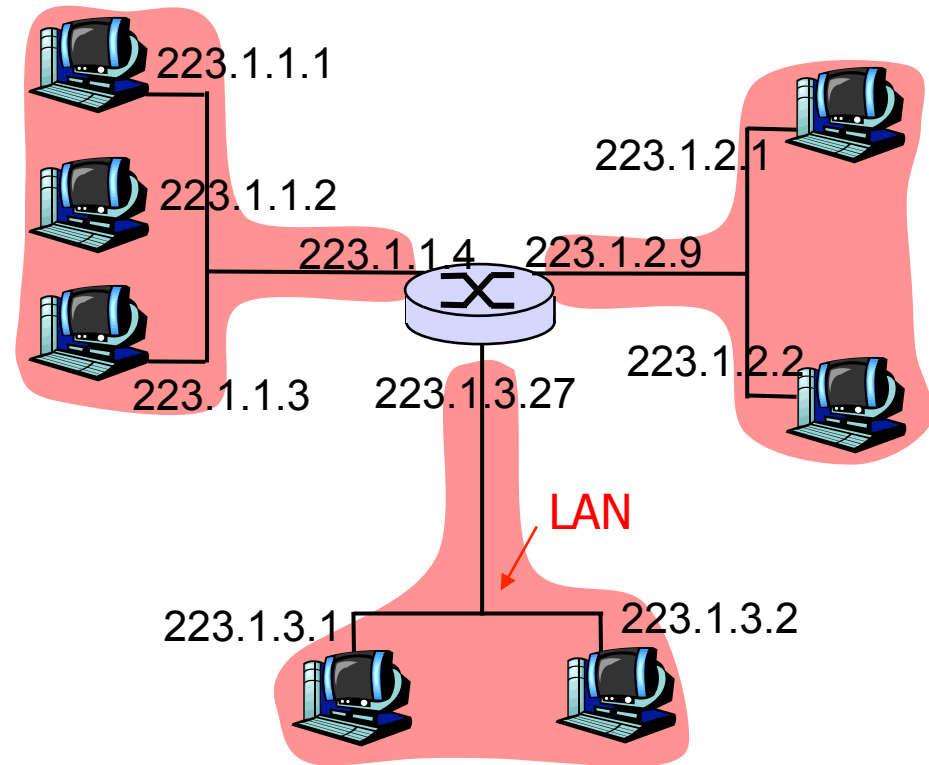

network consisting of 3 IP networks  
(for IP addresses starting with 223,  
first 24 bits are network address)

# IP addressing (3)

How to find the networks?

- ❑ Detach each interface from router, host
- ❑ Create “islands” of isolated networks

Interconnected system consisting of six networks

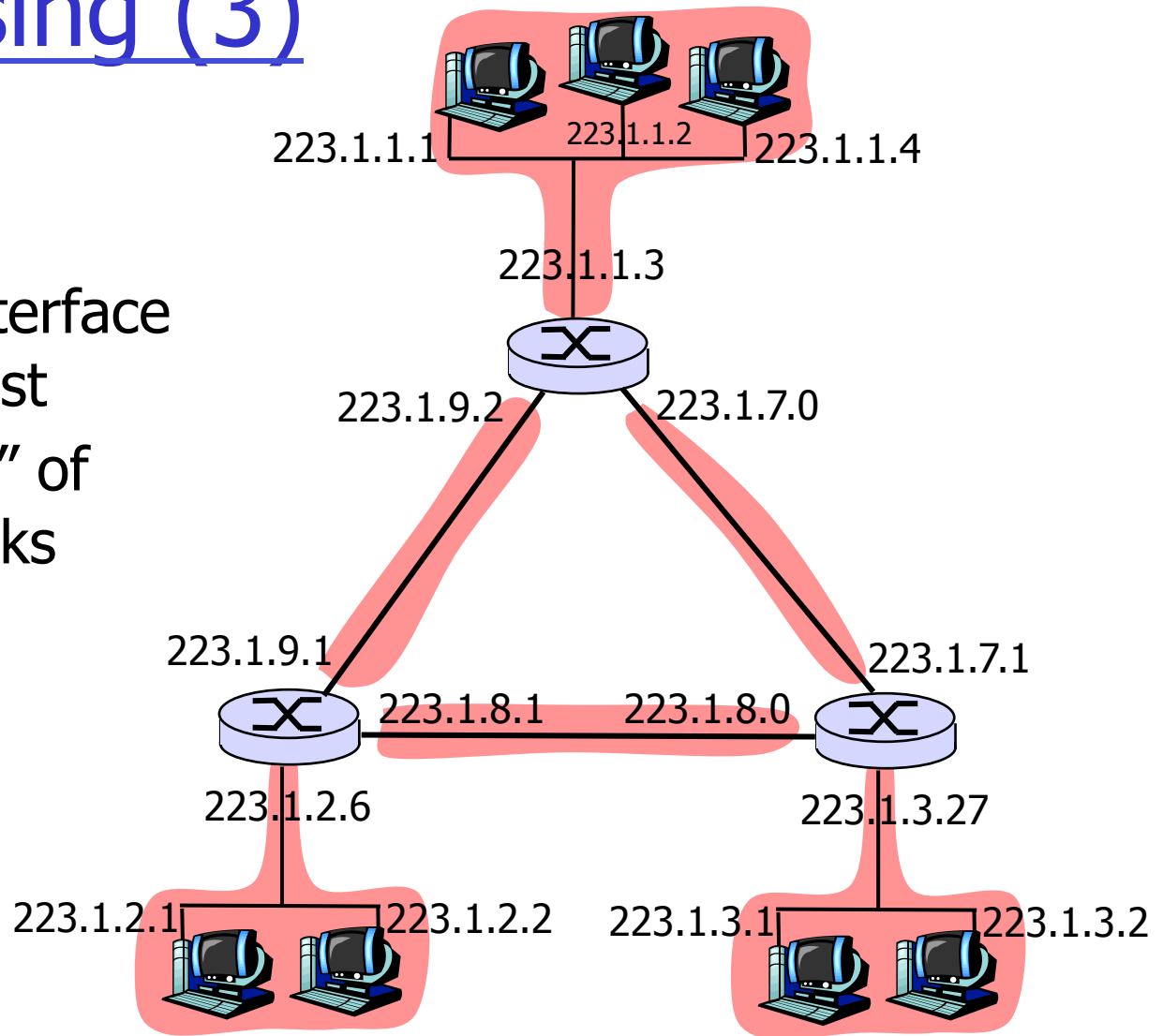

# IP networks: Subnets

- ❑ Sub divide address space
  - Network part
  - Host address
- ❑ Address format: **a.b.c.d/x**, where x is # bits in subnet portion of address

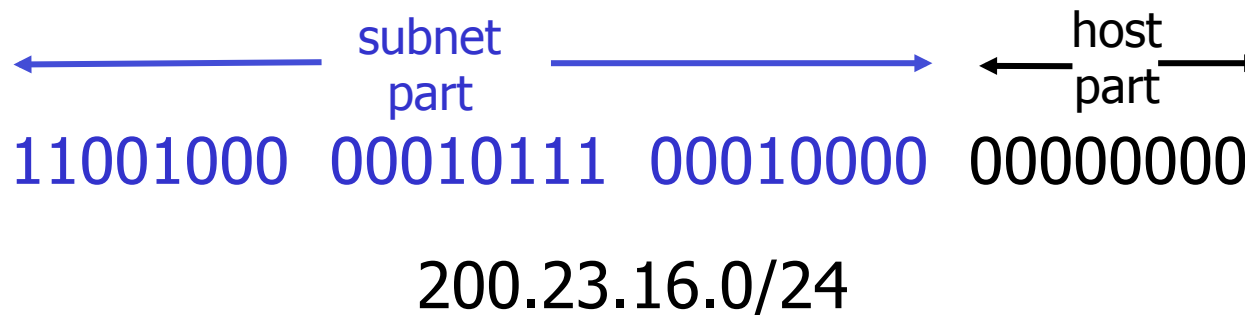

# Fixed subnetting (classful)

class

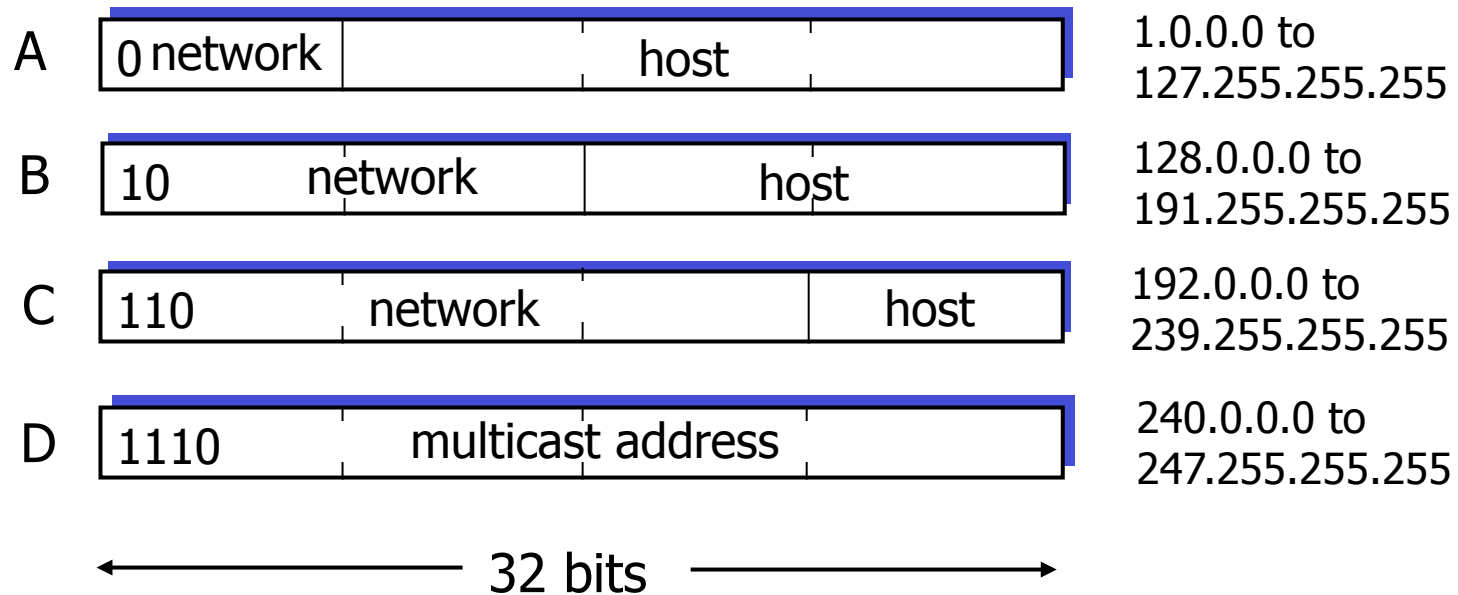

# Address management

- ❑ Problem: we are running out of networks
- ❑ Solution
  - **Subnetting**
  - **CIDR** (Classless Inter Domain Routing)



# CIDR

- ❑ Classless InterDomain Routing
- ❑ Class A is too large, Class C is too small
- ❑ Everyone has a Class B address!!!
  
- ❑ Solution: sites are given contiguous blocks of class-C addresses (256 addresses each) and a mask or parts of former class A/B networks.

# CIDR

## CIDR: Classless InterDomain Routing

- ❑ Subnet portion of address of arbitrary length
- ❑ Address format: **a.b.c.d/x**, where x is # bits in subnet portion of address

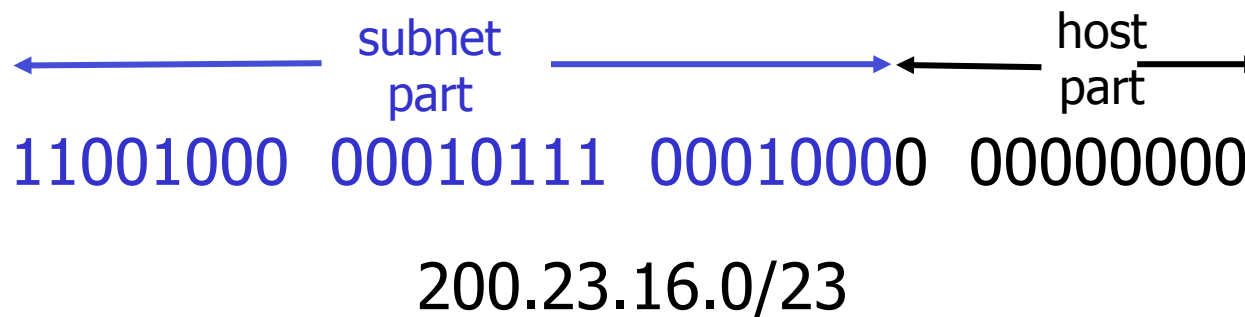

# Hierarchical address structure

## □ Recall: CIDR

128.119.48.12/18 = 10000000 01110111 00110000 00001100

18 relevant bits

- High order bits form the **prefix**
- Once inside the network, can **subnet**: divide remaining bits
- Subnet example:

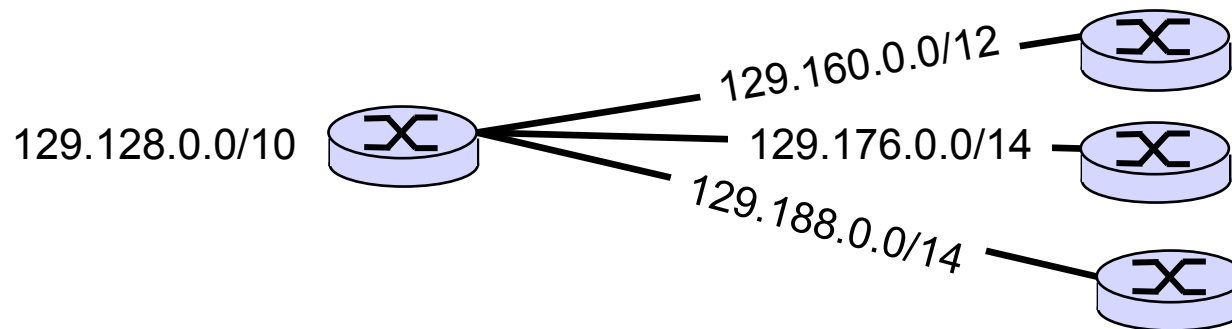

Note: Picture shows prefix masks, not interface addrs!

## □ Forwarding decision: longest prefix match

# Forwarding vs. Routing

- ❑ **Forwarding:** the process of moving packets from input to output
    - The forwarding table
    - Information in the packet
  
  - ❑ **Routing:** process by which the forwarding table is built and maintained
    - One or more routing protocols
    - Procedures (algorithms) to convert routing info to forwarding table.
- (Much more later ...)

# Lookup (longest prefix match):

- ❑ Forwarding table:  
*<Network>/<mask> <next-hop>*
- ❑ IP Packets: destination IP address
  - Find next-hop
- ❑ Example:

Forwarding table

134.96.252.0/24    A

134.96.0.0/16    C

134.96.240.0/20    B

134.96.252.192/28    B

134.96.252.128/28    A

Packets

134.96.252.200

134.96.254.2

134.96.239.200

134.97.239.200

134.96.252.191

# IPv4 datagram format

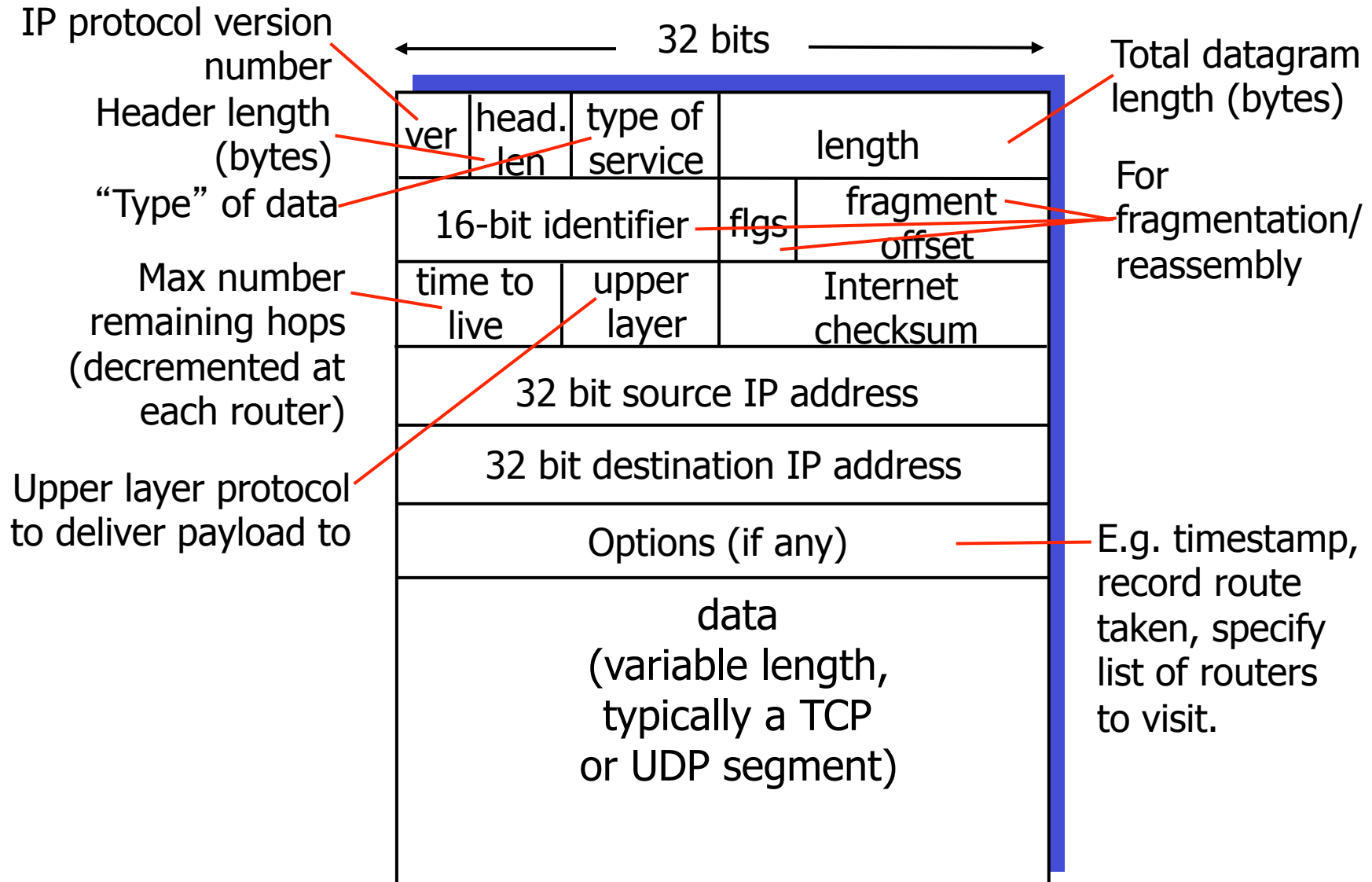

# ICMP: Internet Control Message Protocol

- ❑ Used by hosts, routers, gateways to communicate network-level information
  - Error reporting: unreachable host, network, port, protocol
  - Echo request/reply (used by ping)
- ❑ Network-layer “above” IP:
  - ICMP msgs carried in IP datagrams
- ❑ **ICMP message:** type, code plus first 8 bytes of IP datagram causing error

<u>Type</u>	<u>Code</u>	<u>description</u>
0	0	echo reply (ping)
3	0	dest network unreachable
3	1	dest host unreachable
3	2	dest protocol unreachable
3	3	dest port unreachable
3	6	dest network unknown
3	7	dest host unknown
4	0	source quench (congestion control – not used)
8	0	echo request (ping)
9	0	route advertisement
10	0	router discovery
11	0	TTL expired
12	0	bad IP header

# Network layer: Summary

- ❑ Network layer functions
- ❑ IP
- ❑ Routing and forwarding